

Genie®

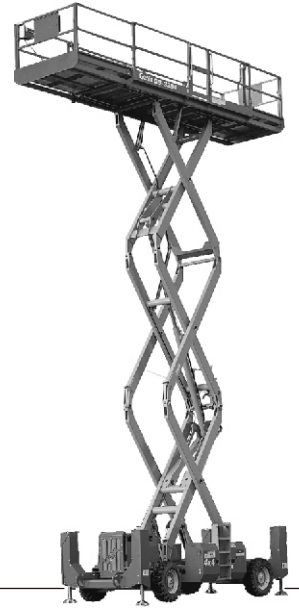

Operator's Manual

with Maintenance Information

Third Edition
Second Printing
Part No. 1000197

GS™-3384

GS™-3390

GS™-4390

GS™-5390

CE Models

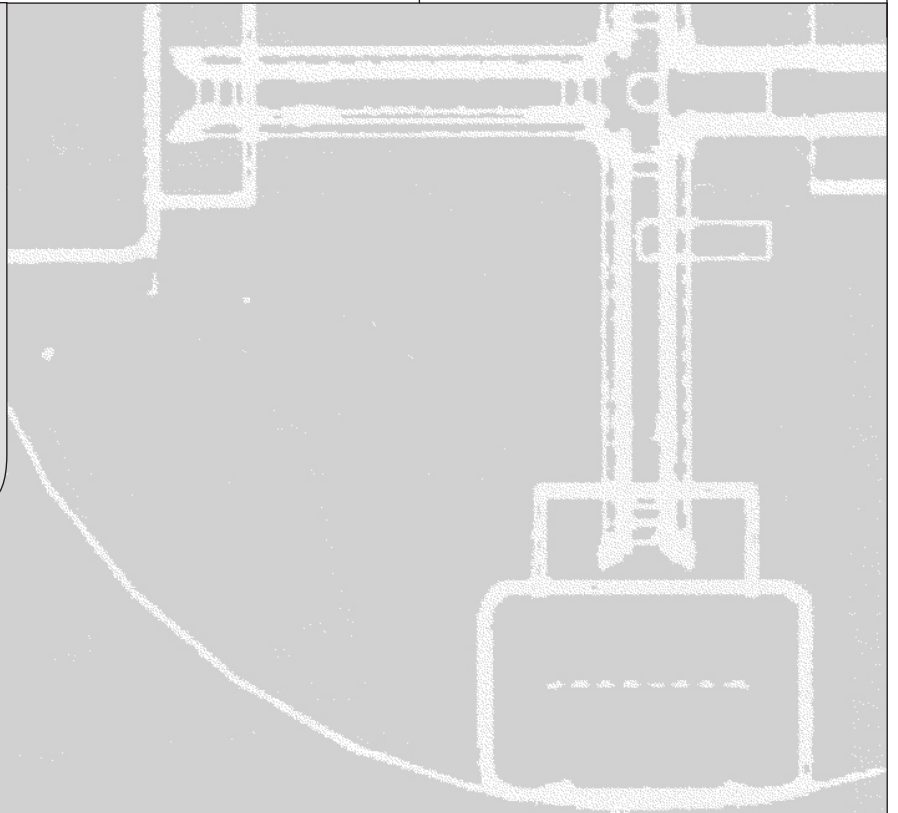

Important

Read, understand and obey these safety rules and operating instructions before operating this machine. Only trained and authorized personnel shall be permitted to operate this machine. This manual should be considered a permanent part of your machine and should remain with the machine at all times. If you have any questions, please call Genie Industries.

Contents

	Page
Safety	1
Legend	9
Controls	10
Pre-operation Inspection	12
Maintenance	14
Function Tests	17
Workplace Inspection	21
Operating Instructions	22
Transport and Lifting Instructions	27
Decals	30
Specifications	32

Contact us:

Internet: <http://www.genielift.com>
 e-mail: techpub@genieind.com

Copyright © 2002 by Genie Industries

First Edition: First Printing, January 2002

Second Edition: Second Printing, October 2004

Third Edition: Second Printing, February 2008

"Genie" is a registered trademark of Genie Industries in the U.S.A. and many other countries. "GS" is a trademark of Genie Industries.

 Printed on recycled paper

Printed in U.S.A.



Safety Rules



Danger

Failure to obey the instructions and safety rules in this manual will result in death or serious injury.

Do Not Operate Unless:

- You learn and practice the principles of safe machine operation contained in this operator's manual.

1 Avoid hazardous situations.

Know and understand the safety rules before going on to the next section.

2 Always perform a pre-operation inspection.

3 Always perform function tests prior to use.

4 Inspect the workplace.

5 Only use the machine as it was intended.

- You read, understand and obey the manufacturer's instructions and safety rules—safety and operator's manuals and machine decals.
- You read, understand and obey employer's safety rules and worksite regulations.
- You read, understand and obey all applicable governmental regulations.
- You are properly trained to safely operate the machine.

SAFETY RULES

Electrocution Hazards

This machine is **not** electrically insulated and will **not** provide protection from contact with or proximity to electrical current.

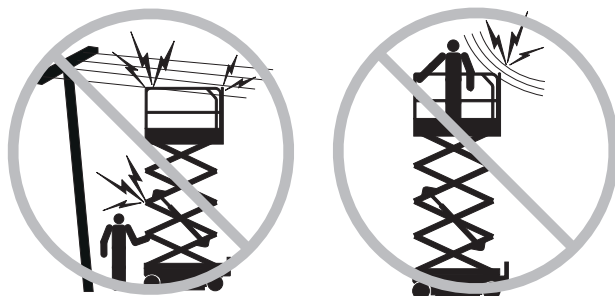

Maintain safe distances from electrical power lines and apparatus in accordance with applicable governmental regulations and the following chart.

Voltage Phase to Phase	Minimum Safe Approach Distance Meters
0 to 300V	Avoid Contact
300V to 50KV	3.05
50KV to 200KV	4.60
200KV to 350KV	6.10
350KV to 500KV	7.62
500KV to 750KV	10.67
750KV to 1000KV	13.72

Allow for platform movement, electrical line sway or sag and beware of strong or gusty winds.

Keep away from the machine if it contacts energized power lines. Personnel on the ground or in the platform must not touch or operate the machine until energized power lines are shut off.

Do not operate the machine during lightning or storms.

Do not use the machine as a ground for welding.

Tip-over Hazards

Occupants, equipment and materials must not exceed the maximum platform capacity.

Machine without capacity indicator:

Maximum capacity	
GS-3384 and GS-3390	1134 kg
GS-4390	680 kg
GS-4390 with extra capacity option	816 kg
GS-5390	680 kg

Machine with capacity indicator:

The maximum capacity varies with the height of the platform.

Maximum capacity - GS-3384 and GS-3390

Maximum capacity - GS-3384 and GS-3390	
Maximum occupants	
7	
Height of Platform	Maximum Capacity
10.1 m	1134 kg
8.5 m	1683 kg
6.4 m	1878 kg
4.2 m	1683 kg
2 m	1134 kg

Maximum capacity - GS-4390

Maximum capacity - GS-4390	
Maximum occupants	
7	
Height of Platform	Maximum Capacity
13.1 m	680 kg
10.1 m	1170 kg
8 m	1286 kg
5.4 m	1170 kg
2.9 m	680 kg

SAFETY RULES

Maximum capacity - GS-4390 with extra capacity option	
Maximum occupants	7
Height of Platform	Maximum Capacity
13.1 m	816 kg
10.2 m	1305 kg
8 m	1421 kg
5.3 m	1305 kg
2.9 m	816 kg
Maximum capacity - GS-5390	
Maximum occupants	4
Height of Platform	Maximum Capacity
16.2 m	680 kg
13.6 m	1264 kg
11 m	1410 kg
8.2 m	1264 kg
2.5 m	680 kg

Do not raise the platform unless the machine is on a firm, level surface.

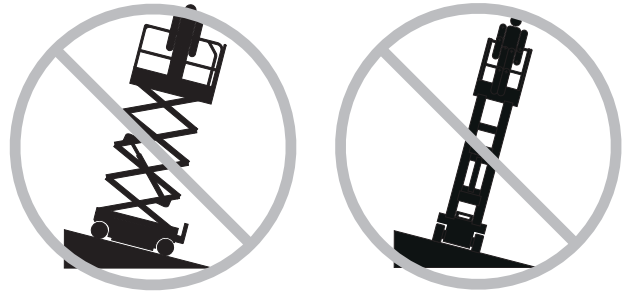

Do not depend on the tilt alarm as a level indicator. The tilt alarm sounds on the chassis and in the platform when the machine is on a slope.

If the tilt alarm sounds:
Lower the platform. Move the machine to a firm, level surface. If the tilt alarm sounds when the platform is raised, use extreme caution to lower the platform.

Do not alter or disable the limit switches.

Do not drive over 1.1 km/h with the platform raised.

Use extreme care and slow speeds while driving the machine in the stowed position across uneven terrain, debris, unstable or slippery surfaces and near holes and drop-offs.

SAFETY RULES

Do not drive the machine on a slope that exceeds the slope and side slope rating of the machine. Slope rating applies to machines in the stowed position.

GS-3384, GS-3390, GS-4390

Maximum slope rating, stowed position	50% (26°)
--	-----------

Maximum side slope rating, stowed position	50% (26°)
---	-----------

GS-5390

Maximum slope rating, stowed position	40% (22°)
--	-----------

Maximum side slope rating, stowed position	40% (22°)
---	-----------

Note: Slope rating is subject to ground conditions and adequate traction.

Do not use the platform controls to free a platform that is caught, snagged or otherwise prevented from normal motion by an adjacent structure. All personnel must be removed from the platform before attempting to free the platform using the ground controls.

Do not push off or pull toward any object outside of the platform.

Maximum allowable manual force
400 N



Do not tie the platform to adjacent structures.

Do not place loads outside the platform perimeter.

Do not alter or disable machine components that in any way affect safety and stability.

Do not modify or alter an aerial work platform without prior written permission from the manufacturer. Mounting attachments for holding tools or other materials onto the platform, toeboards or guard rail system can increase the weight in the platform and the surface area of the platform or the load.

Do not replace items critical to machine stability with items of different weight or specification.

Do not raise the platform when wind speeds may exceed 12.5 m/s. If wind speeds exceed 12.5 m/s when the platform is raised, lower the platform and do not continue to operate the machine.

Do not operate the machine in strong or gusty winds. Do not increase the surface area of the platform or the load. Increasing the area exposed to the wind will decrease machine stability.

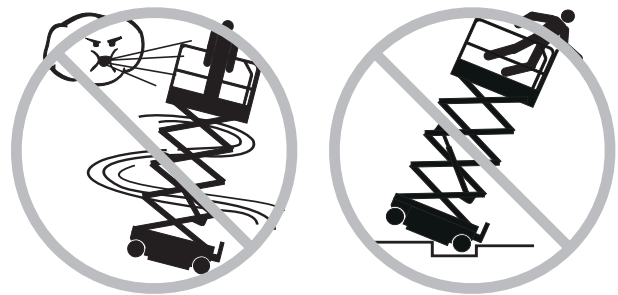

Do not drive the machine on or near uneven terrain, unstable surfaces or other hazardous conditions with the platform raised.

SAFETY RULES

Do not place or attach fixed or overhanging loads to any part of this machine.



Do not place ladders or scaffolds in the platform or against any part of this machine.

Do not transport tools and materials unless they are evenly distributed and can be safely handled by person(s) in the platform.

Do not use the machine on a moving or mobile surface or vehicle.

Be sure all tires are in good condition, air-filled tires are properly inflated and lug nuts are properly tightened.

Do not use the machine as a crane.

Do not push the machine or other objects with the platform.

Do not contact adjacent structures with the platform.

Fall Hazards

The guard rail system provides fall protection. If occupant(s) of the platform are required to wear personal fall protection equipment (PFPE) due to job site or employer rules, PFPE equipment and its use shall be in accordance with the PFPE manufacturer's instructions and applicable governmental requirements.

Do not sit, stand or climb on the platform guard rails. Maintain a firm footing on the platform floor at all times.



Do not climb down from the platform when raised.

Keep the platform floor clear of debris.

Close the entry gate before operating.

Do not operate the machine unless the guard rails are properly installed and the entry is secured for operation.

SAFETY RULES

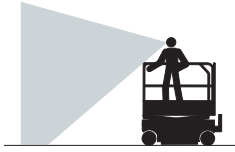
Collision Hazards

Be aware of limited sight distance and blind spots when driving or operating.

Be aware of extended platform position(s) when moving the machine.

Operators must comply with employer, job site and governmental rules regarding use of personal protective equipment.

Check the work area for overhead obstructions or other possible hazards.



Be aware of crushing hazards when grasping the platform guard rail.

Observe and use color-coded direction arrows on the platform controls and platform decal plate for drive and steer functions.

Do not operate a machine in the path of any crane or moving overhead machinery unless the controls of the crane have been locked out and/or precautions have been taken to prevent any potential collision.

No stunt driving or horseplay while operating a machine.

Do not lower the platform unless the area below is clear of personnel and obstructions.



Limit travel speed according to the condition of the ground surface, congestion, slope, location of personnel, and any other factors which may cause collision.

Bodily Injury Hazard

Always operate the machine in a well-ventilated area to avoid carbon monoxide poisoning.

Do not operate the machine with a hydraulic oil or air leak. An air leak or hydraulic leak can penetrate and/or burn skin.

Improper contact with components under any cover will cause serious injury. Only trained maintenance personnel should access compartments. Access by the operator is only advised when performing a pre-operation inspection. All compartments must remain closed and secured during operation.

SAFETY RULES

Component Damage Hazards

Do not use any battery or charger greater than 12V to jump-start the engine.

Do not use the machine as a ground for welding.

Explosion and Fire Hazards

Do not start the engine if you smell or detect liquid petroleum gas (LPG), gasoline, diesel fuel or other explosive substances.

Do not refuel the machine with the engine running.

Refuel the machine and charge the battery only in an open, well-ventilated area away from sparks, flames and lighted tobacco.

Do not operate the machine in hazardous locations or locations where potentially flammable or explosive gases or particles may be present.

Do not spray ether into engines equipped with glow plugs.

Damaged Machine Hazards

Do not use a damaged or malfunctioning machine.

Conduct a thorough pre-operation inspection of the machine and test all functions before each work shift. Immediately tag and remove from service a damaged or malfunctioning machine.

Be sure all maintenance has been performed as specified in this manual and the appropriate Genie service manual.

Be sure all decals are in place and legible.

Be sure the operator's, safety and responsibilities manuals are complete, legible and in the storage container located in the platform.

Crushing Hazards

Keep hands and limbs out of scissors.

Use common sense and planning when operating the machine with the controller from the ground. Maintain safe distances between the operator, the machine and fixed objects.

Maintain a firm grasp on the platform rail when removing the rail pins. Do not allow the platform guard rails to fall.

SAFETY RULES

Outrigger Safety

Tip-over Hazards

Do not lower the outriggers unless the machine is on a firm surface. Avoid drop-offs, holes, unstable or slippery surfaces and other possible hazardous conditions.

When the auto level function is not being used and the outriggers are being lowered individually, the steer-end outriggers must be lowered first.

Do not raise the platform unless the machine is level. Do not set the machine up on a surface where it cannot be leveled using only the outriggers.

Do not raise the platform unless all four outriggers are properly lowered, the footpads are in firm contact with the ground and the machine is level.

Do not adjust the outriggers while the platform is raised.

Do not drive while the outriggers are lowered.

Battery Safety

Burn Hazards

Batteries contain acid. Always wear protective clothing and eye wear when working with batteries.

Avoid spilling or contacting battery acid. Neutralize battery acid spills with baking soda and water.

Explosion Hazard

Keep sparks, flames and lighted tobacco away from batteries. Batteries emit explosive gas.

Electrocution Hazard

Avoid contact with electrical terminals.

Decal Legend

Genie product decals use symbols, color coding and signal words to identify the following:



Safety alert symbol—used to alert personnel to potential personal injury hazards. Obey all safety messages that follow this symbol to avoid possible injury or death.



Red—used to indicate the presence of an imminently hazardous situation which, if not avoided, will result in death or serious injury.



Orange—used to indicate the presence of a potentially hazardous situation which, if not avoided, could result in death or serious injury.



Yellow with safety alert symbol—used to indicate the presence of a potentially hazardous situation which, if not avoided, may cause minor or moderate injury.



Yellow without safety alert symbol—used to indicate the presence of a potentially hazardous situation which, if not avoided, may result in property damage.



Green—used to indicate operation or maintenance information.

Legend

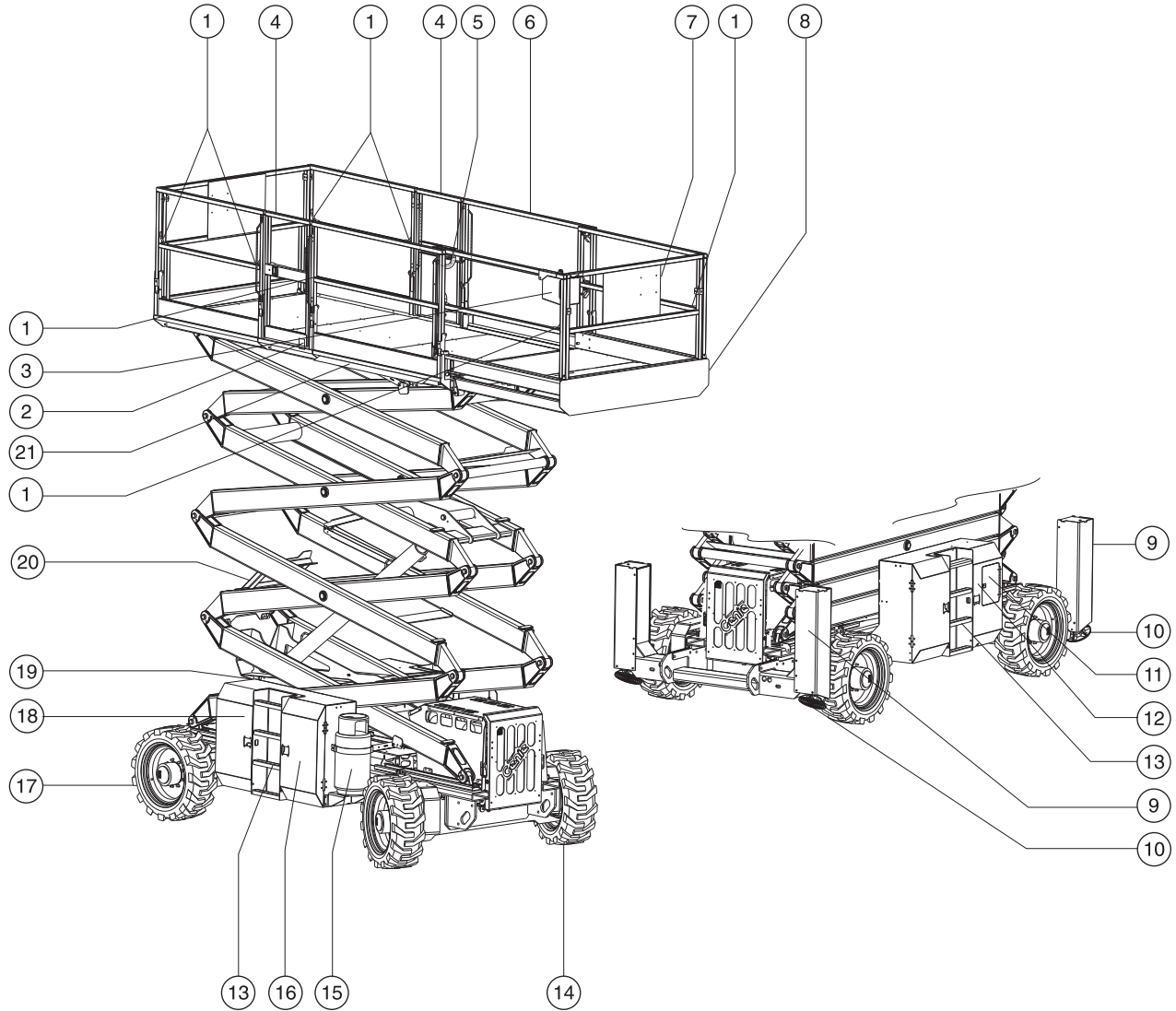

- 1 Lanyard anchorage point
- 2 GFCI outlet
- 3 Platform controls
- 4 Platform entry gate
- 5 Platform extension lock handle
- 6 Platform guard rails
- 7 Manual storage container
- 8 Platform extension

- 9 Outrigger housing (if equipped)
- 10 Outrigger footpad (if equipped)
- 11 Ground controls with LCD readout screen
- 12 Tilt alarm (behind ground control panel)
- 13 Entry ladder
- 14 Steer tire

- 15 LPG tank
- 16 Fuel tank (behind cover)
- 17 Non-steer tire
- 18 Hydraulic tank (behind cover)
- 19 Power to platform (hidden from view)
- 20 Safety arm (hidden from view)
- 21 Capacity indicator (if equipped)



Controls

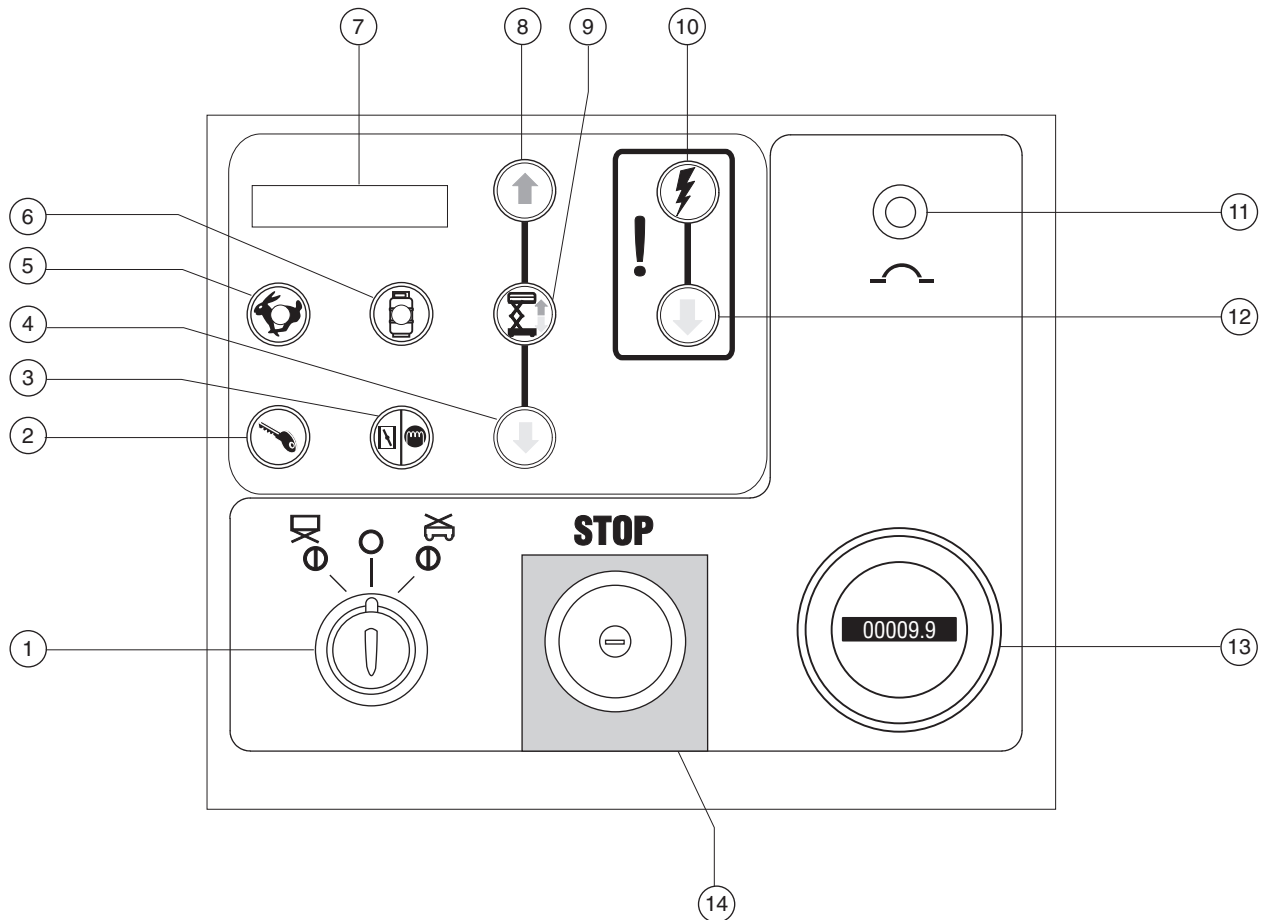

Ground Control Panel

- | | |
|--|---|
| <ul style="list-style-type: none"> 1 Key switch for platform/off/ground control selection 2 Engine start button 3 Gasoline/LPG models: Choke button
Diesel models: Glow plug button 4 Platform down button 5 Idle select button with indicator light 6 Gasoline/LPG models: LPG select button with indicator light 7 LCD readout screen | <ul style="list-style-type: none"> 8 Platform up button 9 Lift function enable button 10 Backup auxiliary function enable button 11 20 amp circuit breaker for controls circuit 12 Backup auxiliary down button 13 Hour meter 14 Red Emergency Stop button |
|--|---|



CONTROLS

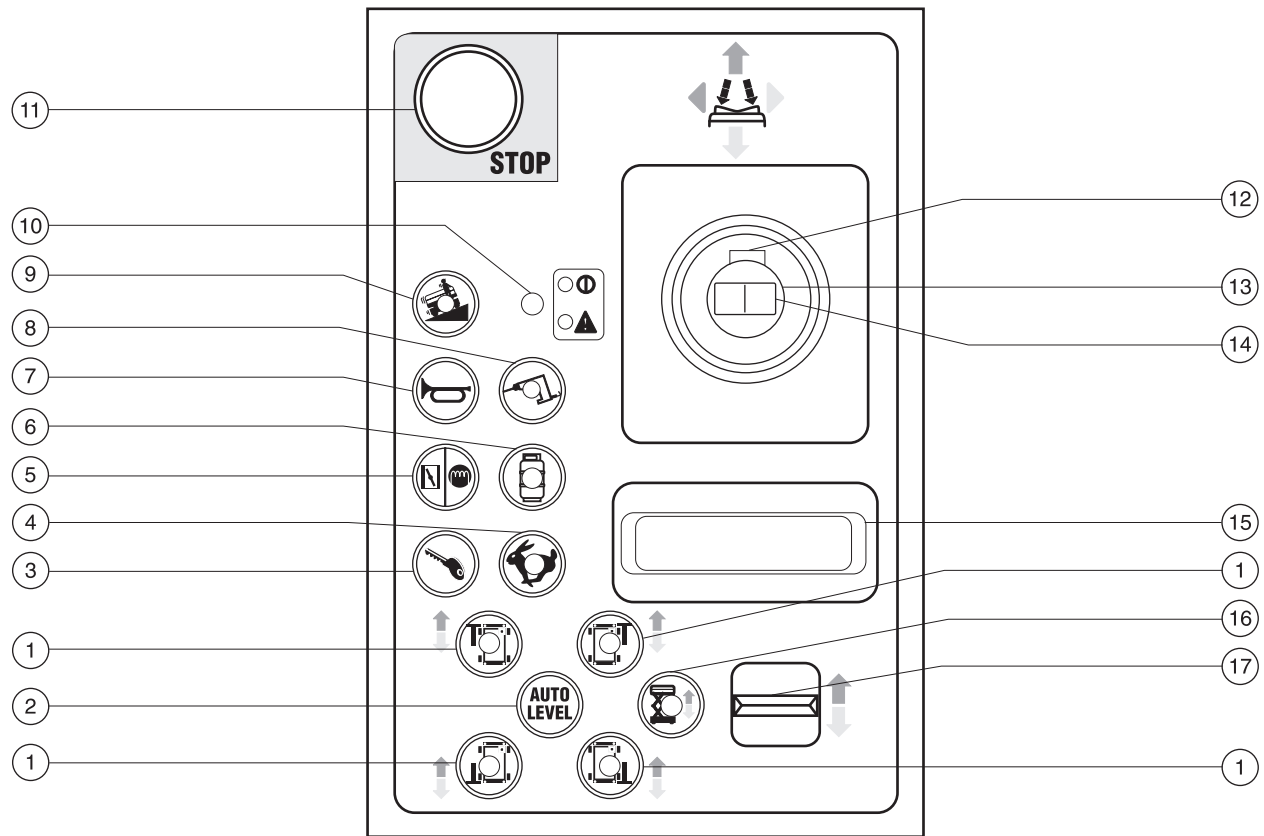

Platform Controls

- | | | | | | |
|---|--|----|--|----|---|
| 1 | Outrigger function enable button with indicator light | 7 | Horn button | 14 | Thumb rocker switch for steer function |
| 2 | Outrigger auto level button | 8 | Generator select button with indicator light | 15 | Wrist rest |
| 3 | Engine start button | 9 | Machine on incline button with indicator light: Low speed operation for inclines | 16 | Lift function enable button with indicator light |
| 4 | Idle select button with indicator light | 10 | Green power light/ Red error indicator light | 17 | Proportional rocker switch for outrigger up/down and platform up/down |
| 5 | Gasoline/LPG models: Choke button
Diesel models: Glow plug button | 11 | Red Emergency Stop button | | |
| 6 | Gasoline/LPG models: LPG select button with indicator light | 12 | Function enable switch | | |
| | | 13 | Proportional control handle for drive function | | |



Pre-operation Inspection



Do Not Operate Unless:

- You learn and practice the principles of safe machine operation contained in this operator's manual.

1 Avoid hazardous situations.

2 Always perform a pre-operation inspection.

Know and understand the pre-operation inspection before going on to the next section.

3 Always perform function tests prior to use.

4 Inspect the workplace.

5 Only use the machine as it was intended.

Fundamentals

It is the responsibility of the operator to perform a pre-operation inspection and routine maintenance.

The pre-operation inspection is a visual inspection performed by the operator prior to each work shift. The inspection is designed to discover if anything is apparently wrong with a machine before the operator performs the function tests.

The pre-operation inspection also serves to determine if routine maintenance procedures are required. Only routine maintenance items specified in this manual may be performed by the operator.

Refer to the list on the next page and check each of the items.

If damage or any unauthorized variation from factory delivered condition is discovered, the machine must be tagged and removed from service.

Repairs to the machine may only be made by a qualified service technician, according to the manufacturer's specifications. After repairs are completed, the operator must perform a pre-operation inspection again before going on to the function tests.

Scheduled maintenance inspections shall be performed by qualified service technicians, according to the manufacturer's specifications and the requirements listed in the responsibilities manual.

PRE-OPERATION INSPECTION

Pre-operation Inspection

- Be sure that the operator's, safety and responsibilities manuals are complete, legible and in the storage container located in the platform.
- Be sure that all decals are legible and in place. See Decals section.
- Check for engine oil leaks and proper oil level. Add oil if needed. See Maintenance section.
- Check for hydraulic oil leaks and proper oil level. Add oil if needed. See Maintenance section.
- Check for engine coolant leaks and proper level of coolant. Add coolant if needed. See Maintenance section.
- Check for battery fluid leaks and proper fluid level. Add distilled water if needed. See Maintenance section.

Check the following components or areas for damage, improperly installed or missing parts and unauthorized modifications:

- Electrical components, wiring and electrical cables
- Hydraulic hoses, fittings, cylinders and manifolds
- Fuel and hydraulic tanks
- Drive motors
- Wear pads
- Tires and wheels
- Engine and related components
- Limit switches, alarms and horn
- Nuts, bolts and other fasteners
- Platform overload components

- Platform entry gate
- Beacon and alarms (if equipped)
- Safety arm
- Platform extension(s)
- Scissor pins and retaining fasteners
- Platform control joystick
- Generator (if equipped)
- Outrigger housings and footpads (if equipped)

Check entire machine for:

- Cracks in welds or structural components
- Dents or damage to machine
- Be sure that all structural and other critical components are present and all associated fasteners and pins are in place and properly tightened
- Side rails are installed and rail pins and bolts are fastened

Maintenance



Observe and Obey:

- ☑ Only routine maintenance items specified in this manual shall be performed by the operator.
- ☑ Scheduled maintenance inspections shall be completed by qualified service technicians, according to the manufacturer's specifications and the requirements specified in the responsibilities manual.

Maintenance Symbols Legend

NOTICE

The following symbols have been used in this manual to help communicate the intent of the instructions. When one or more of the symbols appear at the beginning of a maintenance procedure, it conveys the meaning below.



Indicates that tools will be required to perform this procedure.



Indicates that new parts will be required to perform this procedure.



Indicates that a cold engine is required before performing this procedure.

Check the Batteries



Proper battery condition is essential to good engine performance and operational safety. Improper fluid levels or damaged cables and connections can result in engine component damage and hazardous conditions.

⚠ WARNING

Electrocution hazard. Contact with hot or live circuits may result in death or serious injury. Remove all rings, watches and other jewelry.

⚠ WARNING

Bodily injury hazard. Batteries contain acid. Avoid spilling or contacting battery acid. Neutralize battery acid spills with baking soda and water.

- 1 Put on protective clothing and eye wear.
- 2 Be sure that the battery cable connections are tight and free of corrosion.
- 3 Be sure that the battery hold-down bars are secure.
- 4 Remove the battery vent caps.
- 5 Check the battery acid level. If needed, replenish with distilled water to the bottom of the battery fill tube. Do not overfill.
- 6 Install the vent caps.

MAINTENANCE

Check the Engine Oil Level



Maintaining the proper engine oil level is essential to good engine performance and service life. Operating the machine with an improper oil level can damage engine components.

NOTICE Check the oil level with the engine off.

- 1 Release the latches on the engine tray and fully slide the engine tray out.
- 2 Insert a 15 cm screwdriver or rod into the engine tray lock hole, located near the engine tray roller wheels, to prevent the engine tray from moving.
- 3 Check the oil level dipstick. Add oil as needed.

Deutz F3L2011 Tier II Engine

Oil Type	15W-40
Oil Type - cold conditions	5W-30

Ford LRG-425 EFI Engine, EPA 2004 Compliant

Oil Type	10W-40
Oil Type - cold conditions	5W-30

Check the Hydraulic Oil Level



Maintaining the hydraulic oil at the proper level is essential to machine operation. Improper hydraulic oil levels can damage hydraulic components. Daily checks allow the inspector to identify changes in oil level that might indicate the presence of hydraulic system problems.

NOTICE Perform this procedure with the platform in the stowed position and the engine off.

- 1 Visually inspect the sight gauge located on the side of the hydraulic oil tank.
- ① Result: The hydraulic oil level should be within the top 5 cm of the sight gauge.
- 2 Add oil if necessary. Do not overfill.

Hydraulic oil specifications

Hydraulic oil type	Chevron Rykon Premium MV equivalent
--------------------	--

MAINTENANCE

Check the Engine Coolant Level



Maintaining the engine coolant at the proper level is essential to engine service life. Improper coolant level will affect the engine's cooling capability and damage engine components. Daily checks will allow the inspector to identify changes in coolant level that might indicate cooling system problems.

- 1 Check the fluid level in the radiator. Add fluid as needed.

⚠ WARNING Bodily injury hazard. Fluids in the radiator are under pressure and extremely hot. Use caution when removing cap and adding fluids.

Scheduled Maintenance

Maintenance performed quarterly, annually and every two years must be completed by a person trained and qualified to perform maintenance on this machine according to the procedures found in the service manual for this machine.

Machines that have been out of service for more than three months must receive the quarterly inspection before they are put back into service.

Function Tests



Do Not Operate Unless:

- ☑ You learn and practice the principles of safe machine operation contained in this operator's manual.
 - 1 Avoid hazardous situations.
 - 2 Always perform a pre-operation inspection.
 - 3 Always perform function tests prior to use.**
- Know and understand the function tests before going on to the next section.**
 - 4 Inspect the workplace.
 - 5 Only use the machine as it was intended.

Fundamentals

The function tests are designed to discover any malfunctions before the machine is put into service. The operator must follow the step-by-step instructions to test all machine functions.

A malfunctioning machine must never be used. If malfunctions are discovered, the machine must be tagged and removed from service. Repairs to the machine may only be made by a qualified service technician, according to the manufacturer's specifications.

After repairs are completed, the operator must perform a pre-operation inspection and function tests again before putting the machine into service.

- 1 Select a test area that is firm, level and free of obstruction.

At the Ground Controls

- 2 Pull out the platform and ground red Emergency Stop buttons to the on position.
- 3 Turn the key switch to ground control.
- ⦿ Result: The LCD screen will come on and display SYSTEM READY.

Note: In cold climates, the LCD readout screen will need to warm up before the display appears.

- 4 Start the engine. See Operating Instructions section.

Test Emergency Stop

- 5 Push in the ground red Emergency Stop button to the off position.
 - ⦿ Result: The engine should turn off and no functions should operate.
- 6 Pull out the red Emergency Stop button to the on position and restart the engine.

FUNCTION TESTS

Test Up/Down Functions and Function Enable

The audible warnings on this machine come from the same central alarm. The descent alarm sounds at 60 beeps per minute. The alarm that goes off when the machine is not level sounds at 180 beeps per minute.

- 7 Do not push the lift function enable button. Push and hold the platform up button.



- ⦿ Result: No function should operate.
- 8 Push and hold the lift function enable button. Push and hold the platform up button.
- ⦿ Result: The platform should raise.
- 9 Push and hold the lift function enable button. Push and hold the platform down button.
- ⦿ Result: The platform should lower. The descent alarm should sound while the platform is lowering.

Test the Auxiliary Lowering

- 10 Push and hold the lift function enable button and raise the platform approximately 60 cm.
- 11 Push in the red Emergency Stop button to shut off the engine.
- 12 Pull out the red Emergency Stop button to the on position.
- 13 Push and hold the lift function enable button. Push and hold the platform down button.
- ⦿ Result: The platform should lower.
- 14 Turn the key switch to platform control and restart the engine.

At the Platform Controls**Test Emergency Stop**

- 15 Push in the platform red Emergency Stop button to the off position.
- ⦿ Result: No functions should operate.
- 16 Pull the red Emergency Stop button out to the on position.
- ⦿ Result: The green power light should come on.

Test the Horn

- 17 Push the horn button.
- ⦿ Result: The horn should sound.

Test Up/Down Functions and Function Enable

- 18 Start the engine.
- 19 Activate the up/down rocker switch in the direction indicated by the blue arrow.
- ⦿ Result: The platform should not raise.
- 20 Push and hold the lift function enable button.
- 21 Activate the up/down rocker switch in the direction indicated by the blue arrow.
- ⦿ Result: The platform should raise.
- 22 Push and hold the lift function enable button.
- 23 Activate the up/down rocker switch in the direction indicated by the yellow arrow.
- ⦿ Result: The platform should lower. The descent alarm should sound while the platform is lowering.

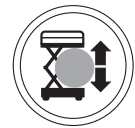

FUNCTION TESTS

Test the Steering

Note: When performing the steer and drive function tests, stand in the platform facing the steer end of the machine.

- 24 Press and hold the function enable switch on the control handle.
- 25 Depress the thumb rocker switch on top of the control handle in the direction identified by the blue triangle on the control panel.
 - ⦿ Result: The steer wheels should turn in the direction that the blue triangle points on the control panel.
- 26 Depress the thumb rocker switch in the direction identified by the yellow triangle on the control panel.
 - ⦿ Result: The steer wheels should turn in the direction that the yellow triangle points on the control panel.

Test Drive and Braking

- 27 Press and hold the function enable switch on the control handle.
- 28 Slowly move the control handle in the direction indicated by the blue arrow on the control panel until the machine begins to move, then return the handle to the center position.
 - ⦿ Result: The machine should move in the direction that the blue arrow points on the control panel, then come to an abrupt stop.
- 29 Press and hold the function enable switch on the control handle.
- 30 Slowly move the control handle in the direction indicated by the yellow arrow on the control panel until the machine begins to move, then return the handle to the center position.
 - ⦿ Result: The machine should move in the direction that the yellow arrow points on the control panel, then come to an abrupt stop.

Note: The brakes must be able to hold the machine on any slope it is able to climb.

Test Limited Drive Speed

- 31 Push and hold the lift function enable button. Raise the platform approximately 1.83 m from the ground.
- 32 Press and hold the function enable switch on the control handle.
- 33 Slowly move the control handle to the full drive position.
 - ⦿ Result: The maximum achievable drive speed with the platform raised should not exceed 31 cm/s.

If the drive speed with the platform raised exceeds 31 cm/s, immediately tag and remove the machine from service.

FUNCTION TESTS

Test the Up Limit Switch and the Outriggers - GS-5390

- 34 Push and hold the lift function enable button. Raise the platform.
- ⦿ Result: The platform should raise to 9.1 m and then stop. The platform should not raise above 9.1 m unless the outriggers are lowered.
- 35 Drive the machine forward.
- ⦿ Result: The drive function should not operate.
- 36 Lower the platform. If the platform is higher than 3.6 m from the ground, the outriggers will not lower.
- 37 Push and hold the auto level button. 
- 38 Activate the up/down rocker switch in the down direction.
- ⦿ Result: The outriggers should extend and level the machine. A beep will sound when the machine is level.
- 39 Raise the platform.
- ⦿ Result: The platform should raise to full height.
- 40 Lower the platform.
- 41 Push and hold the auto level button and raise the outriggers.

Test the Tilt Sensor Operation

Note: Perform this test from the ground with the platform controller. Do not stand in the platform.

- 42 Fully lower the platform.
- 43 Drive both wheels on one side onto an 18 cm block.
- 44 Raise the platform at least 3.6 m.
- ⦿ Result: The platform should stop and the tilt alarm will sound at 180 beeps per minute. The indicator light on the lift function enable button will be red.
- 45 Move the drive control handle in the direction indicated by the blue arrow, then move the drive control handle in the direction indicated by the yellow arrow.
- ⦿ Result: The drive function should not work in either direction.
- 46 Lower the platform and drive the machine off the block.

Test Auxiliary Lowering

- 47 Push and hold the lift function enable button and raise the platform approximately 60 cm.
- 48 Push in the red Emergency Stop button to shut off the engine.
- 49 Pull out the red Emergency Stop button to the on position.
- 50 Push and hold the lift function enable button. Activate the up/down rocker switch in the direction indicated by the yellow arrow.
- ⦿ Result: The platform should lower.

Workplace Inspection



Do Not Operate Unless:

- You learn and practice the principles of safe machine operation contained in this operator's manual.

- 1 Avoid hazardous situations.
- 2 Always perform a pre-operation inspection.
- 3 Always perform function tests prior to use.

4 Inspect the workplace.

Know and understand the workplace inspection before going on to the next section.

- 5 Only use the machine as it was intended.

Workplace Inspection

Be aware of and avoid the following hazardous situations:

- drop-offs or holes
- bumps, floor obstructions or debris
- sloped surfaces
- unstable or slippery surfaces
- overhead obstructions and high voltage conductors
- hazardous locations
- inadequate surface support to withstand all load forces imposed by the machine
- wind and weather conditions
- the presence of unauthorized personnel
- other possible unsafe conditions

Fundamentals

The workplace inspection helps the operator determine if the workplace is suitable for safe machine operation. It should be performed by the operator prior to moving the machine to the workplace.

It is the operator's responsibility to read and remember the workplace hazards, then watch for and avoid them while moving, setting up and operating the machine.

Operating Instructions



Do Not Operate Unless:

- You learn and practice the principles of safe machine operation contained in this operator's manual.
 - 1 Avoid hazardous situations.
 - 2 Always perform a pre-operation inspection.
 - 3 Always perform function tests prior to use.
 - 4 Inspect the workplace.
- 5 Only use the machine as it was intended.**

Fundamentals

The Operating Instructions section provides instructions for each aspect of machine operation. It is the operator's responsibility to follow all the safety rules and instructions in the operator's, safety and responsibilities manuals.

Using the machine for anything other than lifting personnel, along with their tools and materials, to an aerial work site is unsafe and dangerous.

Only trained and authorized personnel should be permitted to operate a machine. If more than one operator is expected to use a machine at different times in the same work shift, they must all be qualified operators and are all expected to follow all safety rules and instructions in the operator's, safety and responsibilities manuals. That means every new operator should perform a pre-operation inspection, function tests, and a workplace inspection before using the machine.

OPERATING INSTRUCTIONS

Emergency Stop

Push in the red Emergency Stop button to the off position at the ground controls or the platform controls to stop all machine functions and turn the engine off.

Repair any function that operates when either red Emergency Stop button is pushed in.

Starting the Engine

- 1 At the ground controls, turn the key switch to the desired position.
- 2 Be sure both ground and platform control red Emergency Stop buttons are pulled out to the on position.

Gasoline/LPG models

- 3 If desired, select LPG by pushing the LPG button.
- 4 Push the engine start button.

Diesel models

- 3 Push and hold the glow plug button for 3 to 5 seconds.
- 4 Push the engine start button.

All models

If the engine fails to start after 15 seconds of cranking, determine the cause and repair any malfunction. Wait 60 seconds before trying to start again.

In cold conditions, -6°C and below, warm the engine for 5 minutes before operating to prevent hydraulic system damage.

In extreme cold conditions, -18°C and below, machines should be equipped with optional cold start kits. Attempting to start the engine when temperatures are below -18°C may require the use of a booster battery.

Gasoline/LPG models: In cold conditions, -6°C and below, the machine should be started on gasoline and warmed for 2 minutes, then switched to LPG. Warm engines can be started on LPG.

Operation From Ground

- 1 Turn the key switch to ground control.
- 2 Pull out both ground and platform red Emergency Stop buttons to the on position.
- 3 Start the engine.

To Position Platform

- 1 Push and hold the lift function enable button.
- 2 Activate the up function or the down function.

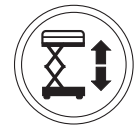

Drive and steer functions are not available from the ground controls.

Engine Idle Select

Select the engine idle (rpm) by pressing the idle select button. There are three settings for engine idle.



- Indicator light off: low idle
- Indicator light blinking: high idle activated by any function enable button
- Indicator light on: high idle

OPERATING INSTRUCTIONS

Operation From Platform

- 1 Turn the key switch to platform control.
- 2 Pull out the ground and platform red Emergency Stop buttons to the on position.
- 3 Start the engine.

To Position Platform

- 1 Push and hold the lift function enable button.
- 2 Activate the up/down rocker switch in the desired direction.



To Steer

- 1 Press and hold the function enable switch on the controller.
- 2 Turn the steer wheels with the thumb rocker switch located on the top of the control handle.

To Drive

- 1 Press and hold the function enable switch on the controller.
- 2 Increase speed: Slowly move the control handle off center.

Decrease speed: Slowly move the control handle toward center.

Stop: Return the control handle to center or release the function enable switch.

Use the color-coded direction arrows on the platform controls and on the platform to identify the direction the machine will travel.

Machine travel speed is restricted when the platform is raised.

Drive Select Switch



Machine on incline symbol:
Low range operation for inclines

Indicator Light On Red



If the indicator light is on red, push in and pull out the red Emergency Stop button to reset the system.

If the light stays red, tag and remove the machine from service.

Indicator Light Flashing Red



If the indicator light is flashing red, the platform is overloaded and no functions will operate. An alarm will sound at the platform controls.

Remove weight from the platform.

Push in and pull out the red Emergency Stop button to reset the system.

If the platform is still overloaded, the light will continue to flash.

Driving on a slope

Determine the slope and side slope ratings for the machine and determine the slope grade.



GS-3384, GS-3390, GS-4390

Maximum slope rating, stowed position 50% (26°)



Maximum side slope rating, stowed position 50% (26°)



GS-5390

Maximum slope rating, stowed position 40% (22°)



Maximum side slope rating, stowed position 40% (22°)

Note: Slope rating is subject to ground conditions and adequate traction.

OPERATING INSTRUCTIONS

To determine the slope grade:

Measure the slope with a digital inclinometer OR use the following procedure.

You will need:

- carpenter's level
- straight piece of wood, at least 1 m long
- tape measure

Lay the piece of wood on the slope.

At the downhill end, lay the level on the top edge of the piece of wood and lift the end until the piece of wood is level.

While holding the piece of wood level, measure the distance from the bottom of the piece of wood to the ground.

Divide the tape measure distance (rise) by the length of the piece of wood (run) and multiply by 100.

Example:

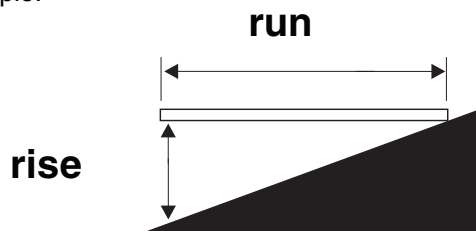

Run = 3.6 m

Rise = 0.3 m

$0.3 \text{ m} \div 3.6 \text{ m} = 0.083 \times 100 = 8.3\%$

If the slope exceeds the maximum slope or side slope rating, then the machine must be winched or transported up or down the slope. See Transport and Lifting section.

To Extend and Retract Platform

- 1 Lift the platform extension lock handle to the horizontal position.
- 2 Push the platform extension lock handle to extend the platform to the desired position.

Do not stand on the platform extension while trying to extend it.

- 3 Lower the platform extension lock handle.

Auxiliary Lowering**At the Ground Controls**

Push and hold the lift function enable button and activate the down function.

In the event of a power failure, use the backup auxiliary lowering function.

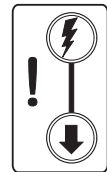
**At the Platform Controls**

Push and hold the lift function enable button and activate the up/down rocker switch in the down direction.

Operation From Ground with Controller

Maintain safe distances between operator, machine and fixed objects.

Be aware of the direction the machine will travel when using the controller.

OPERATING INSTRUCTIONS

Outrigger Operation (if equipped)

- 1 Position the machine below the desired work area.

Note: The engine must be running for the outriggers to operate.

- 2 Push and hold the auto level button. 
- 3 Activate the up/down rocker switch in the down direction. The outriggers will extend and level the machine. A beep will sound when the machine is level.

The indicator light on the lift function enable button will turn red when one but not all outriggers are down. All drive and lift functions are disabled.



The light turns green on the lift function enable button and on the individual outrigger buttons when all the outriggers are in firm contact with the ground.

The drive function is disabled while the outriggers are down.

To control individual outriggers

- 1 Push and hold one or more outrigger buttons.
- 2 Activate the outrigger up/down rocker switch in the desired direction to level the machine.

Fall Protection

Personal fall protection equipment (PFPE) is not required when operating this machine. If PFPE is required by job site or employer rules, the following shall apply:

All PFPE must comply with applicable governmental regulations and must be inspected and used in accordance with the manufacturer's instructions.

After Each Use

- 1 Select a safe parking location—firm level surface, clear of obstructions and traffic.
- 2 Lower the platform.
- 3 Turn the key switch to the off position and remove the key to secure from unauthorized use.
- 4 Chock the wheels.

Transport and Lifting Instructions



Observe and Obey:

- ☑ Common sense and planning must be applied to control the movement of the machine when lifting it with a crane or forklift.
- ☑ The transport vehicle must be parked on a level surface.
- ☑ The transport vehicle must be secured to prevent rolling while the machine is being loaded.
- ☑ Be sure the vehicle capacity, loading surfaces and chains or straps are sufficient to withstand the machine weight. See the serial label for the machine weight.
- ☑ The machine must be on a level surface or secured before releasing the brakes.
- ☑ Do not drive the machine on a slope that exceeds the slope or side slope rating. See Driving on a Slope in the Operating Instructions section.
- ☑ If the slope of the transport vehicle bed exceeds the maximum slope rating, the machine must be loaded and unloaded using a winch as described.

Free-wheel Configuration for Winching

Chock the wheels to prevent the machine from rolling.

2WD models: Release the non-steer wheel brakes by turning over the torque hub disconnect caps (see below).

4WD models: Release the wheel brakes by turning over all four torque hub disconnect caps (see below).

Be sure the winch line is properly secured to the drive chassis tie points and the path is clear of all obstructions.

Reverse the procedures described to re-engage the brakes.

Note: The pump free-wheel valve should always remain closed.

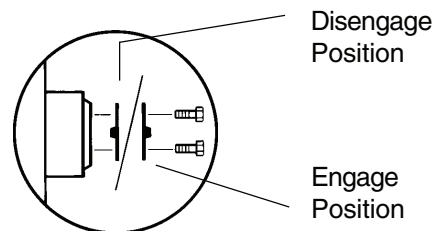

TRANSPORT AND LIFTING INSTRUCTIONS

Securing to Truck or Trailer for Transit

Always chock the machine wheels in preparation for transport.

Retract and secure the extension deck(s).

Use the tie-down points on the chassis for anchoring down to the transport surface.

Use a minimum of four chains or straps.

Use chains or straps of ample load capacity.

Turn the key switch to the off position and remove the key before transporting.

Inspect the entire machine for loose or unsecured items.

If the railings have been folded down, secure them with straps before transporting.

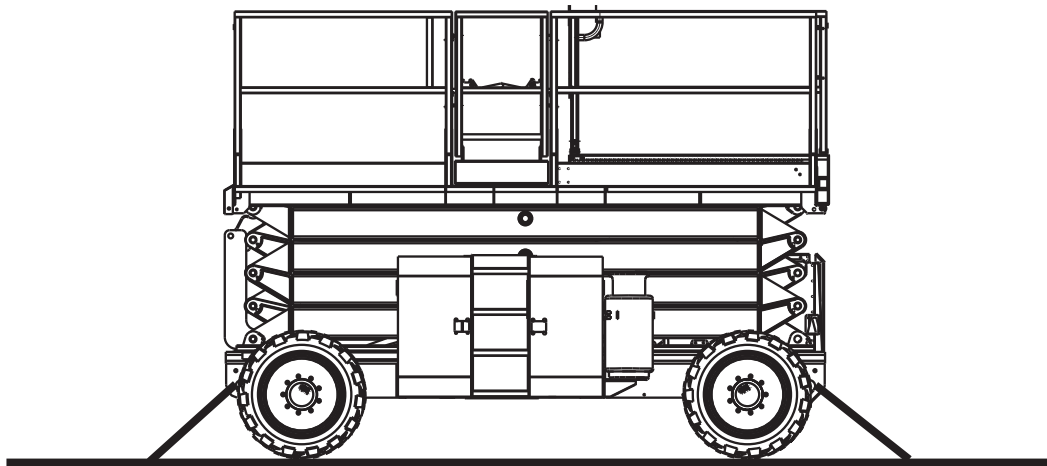
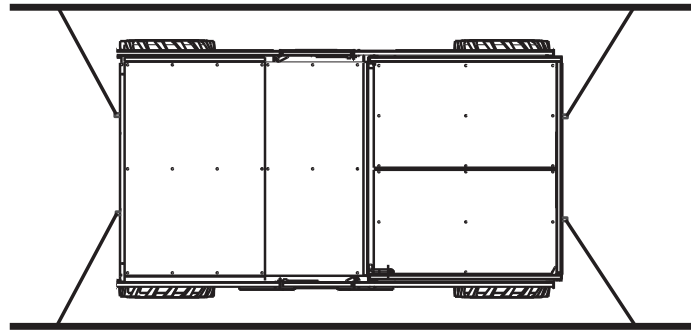

TRANSPORT AND LIFTING INSTRUCTIONS



Observe and Obey:

- Only qualified riggers should rig and lift the machine.
- Be sure the crane capacity, loading surfaces and straps or lines are sufficient to withstand the machine weight. See the serial plate for the machine weight.

Lifting Instructions

Fully lower the platform. Be sure the extension decks, controls and covers are secure. Remove all loose items on the machine.

Determine the center of gravity of your machine using the table and the picture on this page.

Attach the rigging only to the designated lifting points on the machine. There are two lifting points on each end of the machine.

Adjust the rigging to prevent damage to the machine and to keep the machine level.

Center of gravity	X Axis	Y Axis
GS-3384 without outriggers	1.8 m	97.0 cm
GS-3384 with outriggers	1.9 m	94.5 cm
GS-3390 without outriggers	1.8 m	97.0 cm
GS-3390 with outriggers	1.9 m	94.5 cm
GS-4390 without outriggers	1.8 m	1.0 m
GS-4390 with outriggers	1.9 m	1.0 m
GS-5390	1.9 m	1.0 m

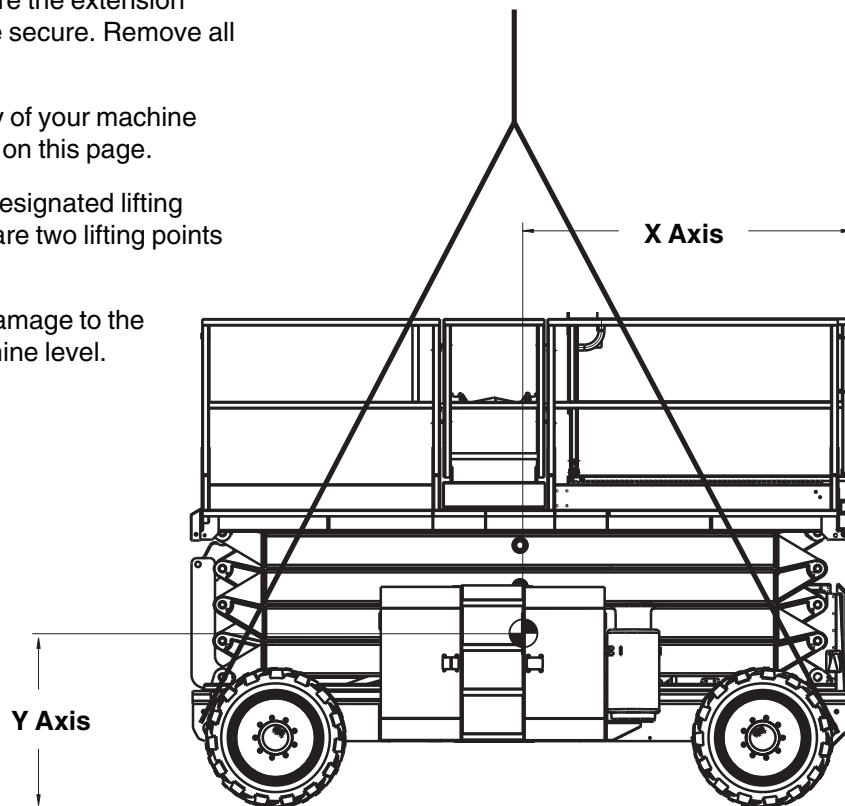

Decals

Decal Inspection

Use the pictures on the next page to verify that all decals are legible and in place.

Below is a numerical list with quantities and descriptions.

Part No.	Description	Quantity
28158	Label - Unleaded	1
28159	Label - Diesel	1
28160	Label - LPG (1 additional with extra LPG tank option)	1
28171	Label - No Smoking	1
28174	Label - Power to Platform, 230V	3
28235	Label - Power to Platform, 115V	3
40434	Label - Lanyard Anchorage	8
43618	Label - Directional Arrows	1
44981	Label - Air Line to Platform	2
52475	Label - Transport Tie-down	4
52967	Cosmetic - 4x4	2
62748	Cosmetic - Genie GS-4390	2
65061	Cosmetic - Genie GS-5390	2
72868	Label - Engine Tray Prop	1
82210	Cosmetic - Genie GS-3384	2
82267	Label - 109 dB	1
82417	Platform Control Panel	1
82418	Ground Control Panel	1
82473	Caution - Compartment Access	2
82474	Warning - Safety Chock	2
82475	Caution - Crushing Hazard	4
82476	Danger - Electrocution Hazard	2
82487	Label - Read the Manual	2
82560	Warning - Skin Injection Hazard	1
82562	Danger - Crushing Hazard	4
82756	Label - Tire Pressure, High Flotation	4
82798	Ground Control Panel	1

Part No.	Description	Quantity
82809	Label - Wheel Load, GS-3384	4
82811	Danger - Max Side Force, 400 N	2
82812	Label - Read the Service Manual	1
82824	Label - Wheel Load, GS-3390 & GS-4390	4
82825	Label - Wheel Load, GS-5390	4
82867	Label - Capacity Indicator, GS-3384 & GS-3390 (if equipped)	1
82868	Label - Capacity Indicator, GS-4390 (if equipped)	1
82869	Label - Capacity Indicator, GS-4390 (models with extra capacity option) (if equipped)	1
82870	Label - Capacity Indicator, GS-5390 (if equipped)	1
82871	Danger - Maximum Capacity, GS-3384 & GS-3390	2
82872	Danger - Maximum Capacity, GS-4390	2
82873	Danger - Maximum Capacity, GS-4390 with one extension deck and outriggers	2
82874	Danger - Maximum Capacity, GS-5390	2
82924	Caution - Component Damage	1
97709	Label - HOT, Ford Tier II Engines	1
97719	Label - Safety Arm	1
97753	Cosmetic - Genie GS-3390	2
133264	Danger - Maximum Capacity, GS-3384 & GS-3390	2
133265	Danger - Maximum Capacity, GS-4390	2
133266	Danger - Maximum Capacity, GS-4390 with one extension deck and outriggers	2
133267	Danger - Maximum Capacity, GS-5390	2
133269	Label - Outrigger Load, GS-3384	4
133270	Label - Outrigger Load, GS-3390	4
133271	Label - Outrigger Load, GS-4390	4
133272	Label - Outrigger Load, GS-5390	4

 Shading indicates decal is hidden from view, i.e. under covers

DECALS

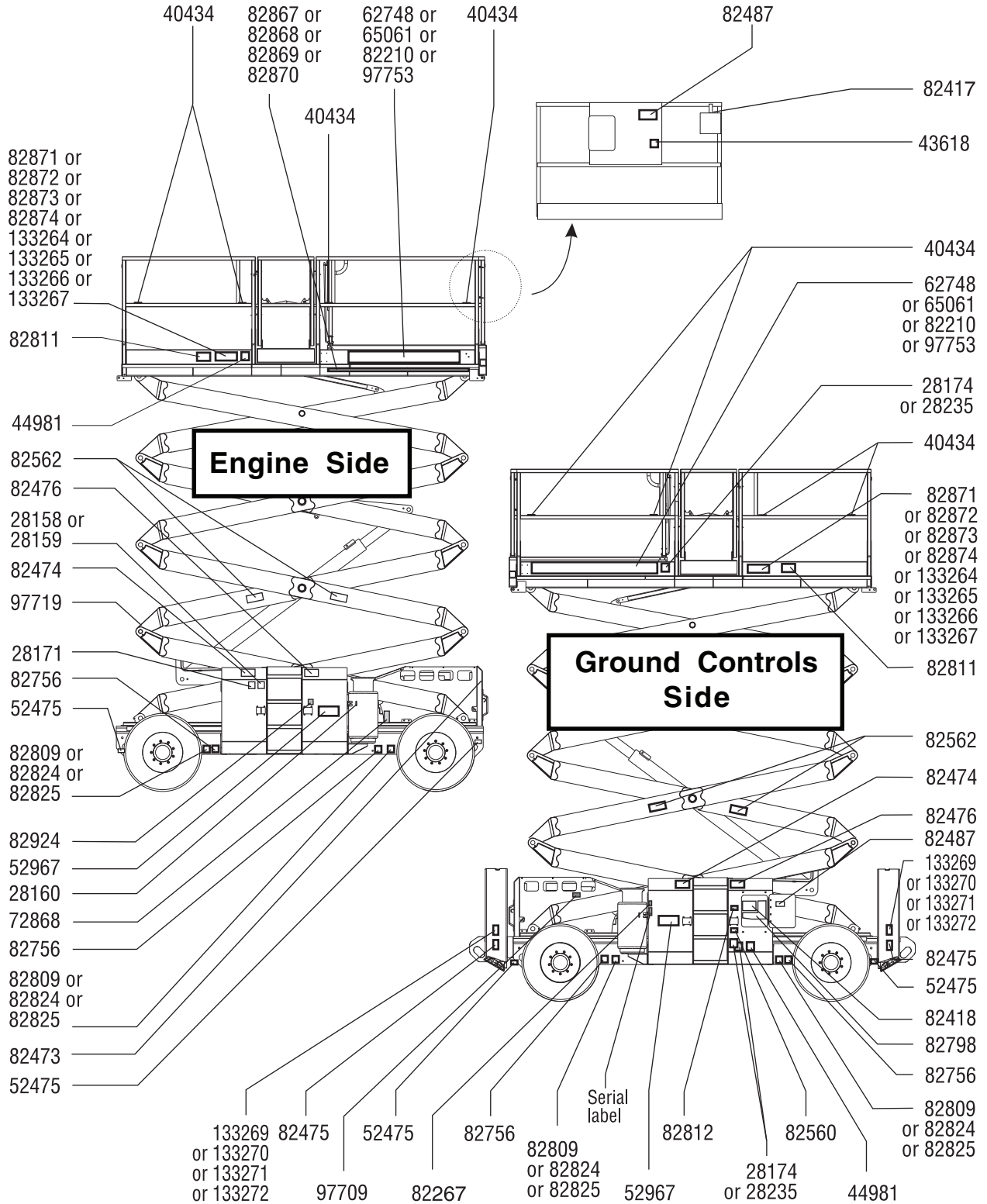

Specifications

Model	GS-3384
Height, working maximum	12.1 m
Height, platform maximum	10.1 m
Height, stowed maximum Rails up	2.7 m
Height, stowed maximum Rails lowered	2.0 m
Width, standard tires	2.1 m
Length, platform retracted Models with one extension deck	3.9 m
Length, platform extended Models with one extension deck	5.4 m
Length, platform retracted Models with two extension decks	3.9 m
Length, platform extended Models with two extension decks	6.6 m
Length, platform retracted Models with outriggers Models with two super decks	4.9 m
Length, platform extended Models with two super decks	7.4 m
Maximum load capacity (machines without capacity indicator)	1134 kg
Maximum load capacity (machines with capacity indicator)	1134 - 1878 kg
Maximum wind speed	12.5 m/s
Wheelbase	2.9 m
Turning radius (outside)	5.9 m
Turning radius (inside)	3.1 m
Ground clearance	33 cm
Weight (Machine weights vary with option configurations)	See Serial Label

Platform dimensions

Platform length x width	3.8 x 1.8 m
Platform extension length	1.5 m

Drive speeds

Stowed, maximum	6.4 km/h
Platform raised, maximum	1.1 km/h 12.2 m/39 sec

Controls	Proportional
----------	--------------

AC outlet in platform	standard
-----------------------	----------

Airborne noise emissions Maximum sound level at normal operating workstations (A-weighted)	80 dB
--	-------

Maximum hydraulic pressure (functions)	241.3 bar
---	-----------

Tire size - standard tires	10-16.5 NHS
----------------------------	-------------

Maximum slope rating, stowed position	50% (26°)
--	-----------

Maximum side slope rating, stowed position	50% (26°)
---	-----------

Note: Slope rating is subject to ground conditions and adequate traction.

Floor loading information

Tire load, maximum	1724 kg
--------------------	---------

Outrigger load, maximum (if equipped)	2059 kg
---------------------------------------	---------

Tire contact pressure	8.91 kg/cm ² 873 kPa
-----------------------	------------------------------------

Occupied floor pressure	783 kg/m ² 7.68 kPa
-------------------------	-----------------------------------

Note: Floor loading information is approximate and does not incorporate different option configurations. It should be used only with adequate safety factors.

Continuous improvement of our products is a Genie policy. Product specifications are subject to change without notice or obligation.



SPECIFICATIONS

Model	GS-3390
Height, working maximum	12.1 m
Height, platform maximum	10.1 m
Height, stowed maximum Rails up	2.7 m
Height, stowed maximum Rails lowered	2.0 m
Width, standard tires	2.3 m
Length, platform retracted Models with one extension deck	3.9 m
Length, platform extended Models with one extension deck	5.4 m
Length, platform retracted Models with two extension decks	3.9 m
Length, platform extended Models with two extension decks	6.6 m
Length, platform retracted Models with outriggers Models with two super decks	4.9 m
Length, platform extended Models with two super decks	7.4 m
Maximum load capacity (machines without capacity indicator)	1134 kg
Maximum load capacity (machine with capacity indicator)	1134 - 1878 kg
Maximum wind speed	12.5 m/s
Wheelbase	2.9 m
Turning radius (outside)	5.3 m
Turning radius (inside)	2.2 m
Ground clearance	36 cm
Weight (Machine weights vary with option configurations)	See Serial Label

Platform dimensions	
Platform length x width	3.8 x 1.8 m
Platform extension length	1.5 m
Drive speeds	
Stowed, maximum	8 km/h
Platform raised, maximum	1.1 km/h 12.2 m/39 sec
Controls	Proportional
AC outlet in platform	standard
Airborne noise emissions Maximum sound level at normal operating workstations (A-weighted)	80 dB
Maximum hydraulic pressure (functions)	241.3 bar
Tire size - standard tires	12 x 21.5
Maximum slope rating, stowed position	50% (26°)
Maximum side slope rating, stowed position	50% (26°)
Note: Slope rating is subject to ground conditions and adequate traction.	
Floor loading information	
Tire load, maximum	2041 kg
Outrigger load, maximum (if equipped)	2068 kg
Tire contact pressure	8.80 kg/cm ² 862 kPa
Occupied floor pressure	735 kg/m ² 7.21 kPa

Note: Floor loading information is approximate and does not incorporate different option configurations. It should be used only with adequate safety factors.

Continuous improvement of our products is a Genie policy. Product specifications are subject to change without notice or obligation.



SPECIFICATIONS

Model	GS-4390		
Height, working maximum	15.1 m	Ground clearance	36 cm
Height, platform maximum	13.1 m	Weight	See Serial Label (Machine weights vary with option configurations)
Height, stowed maximum Rails up	2.9 m	Platform dimensions	
Height, stowed maximum Rails lowered	2.3 m	Platform length x width	3.8 x 1.8 m
Width, standard tires	2.3 m	Platform extension length	1.5 m
Width, high-flotation tires	2.6 m	Drive speeds	
Length, platform retracted Models with one extension deck	3.9 m	Stowed, maximum	8 km/h
Length, platform extended Models with one extension deck	5.4 m	Platform raised, maximum	1.1 km/h 12.2 m/39 sec
Length, platform retracted Models with two extension decks	3.9 m	Controls	Proportional
Length, platform extended Models with two extension decks	6.6 m	AC outlet in platform	standard
Length, platform retracted Models with outriggers Models with two super decks	4.9 m	Airborne noise emissions	80 dB Maximum sound level at normal operating workstations (A-weighted)
Length, platform extended Models with two super decks	7.4 m	Maximum hydraulic pressure (functions)	241.3 bar
Maximum load capacity All models except the model listed below (machines without capacity indicator)	680 kg	Tire size - standard tires	12 x 21.5
Maximum load capacity GS-4390 with extra capacity option (machines without capacity indicator)	816 kg	Tire size - high flotation tires	33/16LL500, 10 ply
Maximum load capacity All models except the model listed below (machines with capacity indicator)	680 - 1286 kg	Maximum slope rating, stowed position	
Maximum load capacity GS-4390 with extra capacity option (machines with capacity indicator)	816 - 1421 kg	50% (26°)	
Maximum wind speed	12.5 m/s	Maximum side slope rating, stowed position	
Wheelbase	2.9 m	50% (26°)	
Turning radius (outside)	5.3 m	Note: Slope rating is subject to ground conditions and adequate traction.	
Turning radius (inside)	2.2 m	Floor loading information	
		Tire load, maximum	2041 kg
		Outrigger load, maximum (if equipped)	2126 kg
		Tire contact pressure	8.80 kg/cm ² 862 kPa
		Occupied floor pressure	735 kg/m ² 7.21 kPa

Note: Floor loading information is approximate and does not incorporate different option configurations. It should be used only with adequate safety factors.

Continuous improvement of our products is a Genie policy. Product specifications are subject to change without notice or obligation.



SPECIFICATIONS

Model	GS-5390
Height, working maximum	18.2 m
Height, platform maximum	16.2 m
Height, stowed maximum Rails up	3.2 m
Height, stowed maximum Rails lowered	2.5 m
Width, standard tires	2.3 m
Width, high-flotation tires	2.6 m
Length, platform retracted Models with one extension deck	4.9 m
Length, platform extended Models with one extension deck	5.9 m
Length, platform retracted Models with two extension decks	4.9 m
Length, platform extended Models with two extension decks	6.6 m
Length, platform retracted Models with outriggers Models with two super decks	4.9 m
Length, platform extended Models with two super decks	7.4 m
Maximum load capacity (machines without capacity indicator)	680 kg
Maximum load capacity (machines with capacity indicator)	680 - 1410 kg
Maximum wind speed	12.5 m/s
Wheelbase	2.9 m
Turning radius (outside)	5.3 m
Turning radius (inside)	2.2 m
Ground clearance	36 cm
Weight (Machine weights vary with option configurations)	See Serial Label

Platform dimensions	
Platform length x width	3.8 x 1.8 m
Platform extension length	1.5 m
Drive speeds	
Stowed, maximum	8 km/h
Platform raised, maximum	1.1 km/h 12.2 m/39 sec
Controls	Proportional
AC outlet in platform	standard
Airborne noise emissions Maximum sound level at normal operating workstations (A-weighted)	80 dB
Maximum hydraulic pressure (functions)	241.3 bar
Tire size - standard tires	12 x 21.5
Tire size - high flotation tires	33/16LL500, 10 ply
Maximum slope rating, stowed position	40% (22°)
Maximum side slope rating, stowed position	40% (22°)
Note: Slope rating is subject to ground conditions and adequate traction.	
Floor loading information	
Tire load, maximum	2404 kg
Outrigger load, maximum	2266kg
Tire contact pressure	10.36 kg/cm ² 1015 kPa
Occupied floor pressure	912 kg/m ² 8.95 kPa
Note: Floor loading information is approximate and does not incorporate different option configurations. It should be used only with adequate safety factors.	

Continuous improvement of our products is a Genie policy. Product specifications are subject to change without notice or obligation.



Genie Scandinavia
Phone +46 31 575100
Fax +46 31 579020

Genie France
Phone +33 (0)2 37 26 09 99
Fax +33 (0)2 37 26 09 98

Genie Iberica
Phone +34 93 579 5042
Fax +34 93 579 5059

Genie Germany
Phone +49 (0)4202 88520
Fax +49 (0)4202 8852-20

Genie U.K.
Phone +44 (0)1476 584333
Fax +44 (0)1476 584334

Genie Mexico City
Phone +52 55 5666 5242
Fax +52 55 5666 3241

Genie North America
Phone 425.881.1800
Toll Free USA and Canada
800.536.1800
Fax 425.883.3475

Genie Australia Pty Ltd.
Phone +61 7 3375 1660
Fax +61 7 3375 1002

Genie China
Phone +86 21 53852570
Fax +86 21 53852569

Genie Malaysia
Phone +65 98 480 775
Fax +65 67 533 544

Genie Japan
Phone +81 3 3453 6082
Fax +81 3 3453 6083

Genie Korea
Phone +82 25 587 267
Fax +82 25 583 910

Genie Brasil
Phone +55 11 41 665 755
Fax +55 11 41 665 754

Genie Holland
Phone +31 183 581 102
Fax +31 183 581 566

Distributed by: